

# COBRA<sup>X</sup>PRO<sup>®</sup>

– auto glass repair and replacement systems



The market's fastest, best and most user-friendly solutions



Registered design



Registered design



Danish design  
Made in Denmark

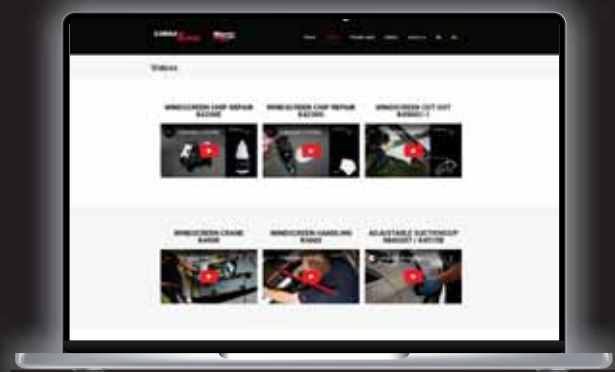

Demonstration videos on  
[cobraxpro.com](https://cobraxpro.com)

# Unique technology, tools in registered design, accessories and consumables

Our programme of tools, accessories and consumables for professional auto glass repair has been developed and tested in collaboration with leading specialists in the automotive glass industry.

The programme includes technology and tools in registered design that position us as a leading supplier of solutions within repair and replacement of auto glass.

The product range is also offered in private label brand to wholesalers in the automotive industry, which in addition to thorough training (training academy) also receives marketing material - including videos made available.



## Auto glass chip repair

In windscreen chip repair, we set completely new standards for speed, simplicity and repair quality. Compared to other repair systems - with a minimum of training - stone chip repairs can be carried out in just 5 minutes and with a success rate of 95-98%.

The repair process requires neither access to power nor vacuum equipment, is mobile and can therefore also be performed at the customer.

Depending on the need, the repair kits are available in four different versions. The contents and the necessary consumables can be ordered separately.

Get detailed information on the following pages ...

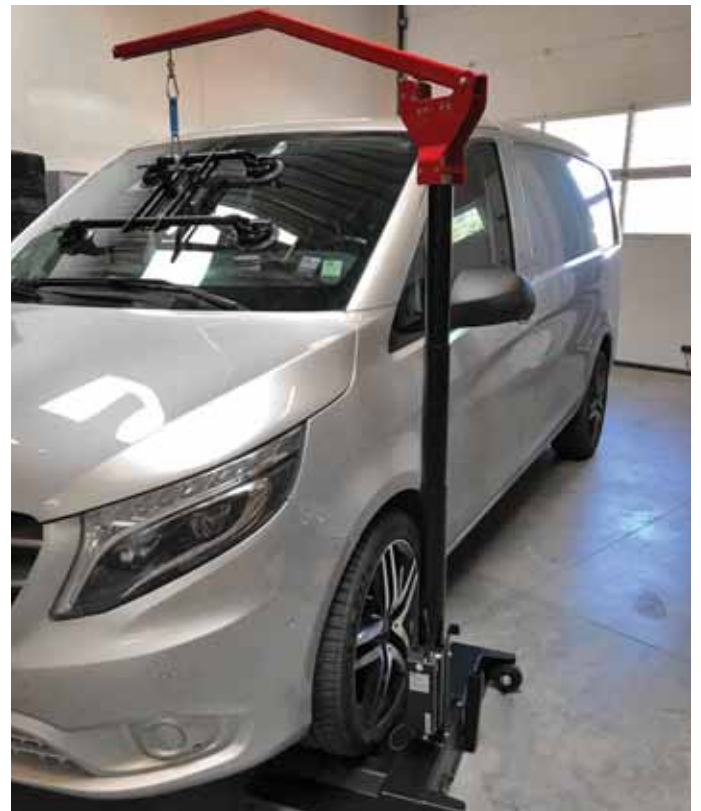

## Auto glass replacement

With in-house developed tools, we also set new standards for speed, simplicity and repair quality within autoglass removal.

By using our cutting set, the cutting work - with a minimum of training - can not only be performed much faster, but also by just one person and with all types of cutting wire/thread.

Depending on the need, the cut-out kits are available in two different versions. The contents and the necessary consumables can be ordered separately.

Get detailed information on the following pages ...

## New standard for both speed, simplicity, repair quality and mobility

There are several chip repair systems on the market, but no other performs as well on the four most important parameters:

- Speed
- Simplicity
- Repair quality
- Mobility

### Chip repair in just 5 minutes

With our 3-in-1 process, a chip repair can be performed in just 5 minutes. After ordinary preparation and cleaning of the chip, the following process steps are performed with our in-house developed repair bridge in registered design:

1. Heating to 60° C and cooling to 20° C in 3 min.
2. Filling and pressure/vacuum process of 60 sec.
3. Curing (LED UV curing 30 sec. and with 95-98% invisibility after curing)



### Everyone can do chip repairs after a brief introduction

Our system is so simple to work with that EVERYONE - after a short introduction - can do the work. So no special prerequisites are required. It is therefore obvious for car repair shops to offer their customers this service.



## Nice and long lasting repairs

Our specially developed resin differs in several ways. The special viscosity of the resin ensures that it flows out into even the smallest cracks, which has an impact on how efficiently the cracks in the damaged area are joined together and thereby the quality and service life of the repair. The resin also differs by not yellowing over time. This results in a nicer repair.

But also our pit filler differs in several areas. Like the resin, it does not yellow over time and in addition it is characterized by a very high wear resistance. This ensures both a long service life and a nicer repair.

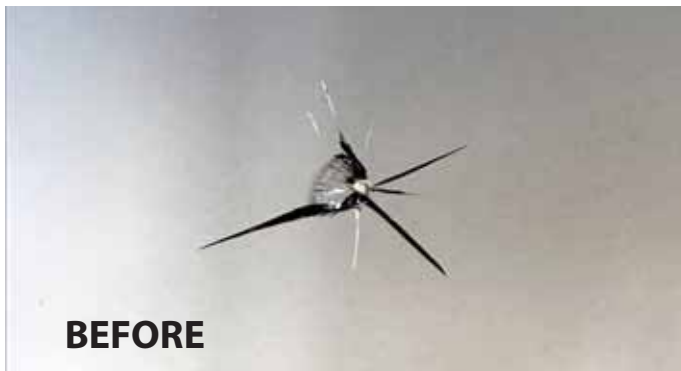

## In the workshop or on the road

Most stone chip repair processes include the use of vacuum technology, which often makes mobile use a challenge. With our in-house developed pressure/vacuum tool in registered design, repairs can be carried out at the customer's as well as in the workshop. A stone chip repair requires NO access to electricity or the like.

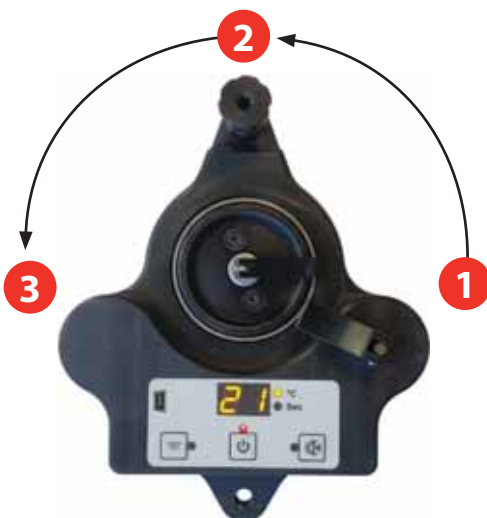

## In private label and with everything you need to get off to a good start

The product range is also offered in private label to wholesalers in the automotive aftermarket. In addition to the mandatory training and coaching of the wholesaler's staff, we also offer marketing material so that you as a wholesaler get off to a good and quick start, for example:

- Brochures
- Demonstration video with own employees
- Website setup with customer support function
- Sticker for covering chip with contact details





## K4200C

Varenummer	Navn
K4213-2	Repair bridge 3in1
K4213	Repair bridge
K4215A	UV-led lamp 30 sec. curing time
3027	Charging cabel
K4221-1	Glass drill machine 3,6 V incl. charging cable
K4212-5	Glass drills ball ended x 5
K4208-1	Pressure/vacuum piston and syringe
K4220	Slide hammer
K4219	Crack expander
K4230	Curing film square x 5
K4210	Curing film roll
K4211	Razor blades x 5
K4205	Pit filler 5 ml
K4214-1	Mirror with suction cup adjustable
910008	Syring and needle
K4207-1	Gel 10 ml
K4202	Crack resin 5 ml
K4206-1	Polish 10 ml
3012	Box for K4200C and K4200H
2060	Lighter
4008	Adapter 220 V
K4202-2	Resin set ( 10 x pipette )
K4202-3	Crack resin set 1 ( K4208-1, 910008, K4202 )
K4202-4	Pit filler set 2 ( K4211, K4230, K4205 )



## K4200H

Varenummer	Navn
K4213-2	Repair bridge 3in1
K4221-1	Glass drill machine 3,6 V incl. charging cable
K4212-5	Glass drills ball ended x 5
K4208-1	Pressure/vacuum piston and syringe
K4220	Slide hammer
K4230	Curring film square x 5
K4210	Curring film roll
K4211	Razor blades x 5
K4205	Pit filler 5 ml
K4214-1	Mirror with suction cup adjustable
910008	Syring and needle
K4207-1	Gel 10 ml
K4202	Crack resin 5 ml
K4206-1	Polish 10 ml
3012	Box for K4200C and K4200H
2060	Lighter
4008	Adapter 220 V
K4202-2	Resin set ( 10 x pipette )
K4202-3	Crack resin set 1 ( K4208-1, 910008, K4202 )
K4202-4	Pit filler set 2 ( K4211, K4230, K4205 )



Demonstration videos on  
**cobraxpro.com**





## K4200D

Varenummer	Navn
K4213-2	Repair bridge 3in1
3027	Charging cabel
K4214	Mirror with suction cup
K4208-1	Pressure/vacuum piston and syringe
K4230	Curring film square x 5
K4211	Razor blades x 5
K4202	Crack resin 5 ml
K4205	Pit filler 5 ml
K4206-1	Polish 10 ml
910008	Syring and needle
3010	Box for K4200D



## K4200G

Varenummer	Navn
K4213-3	Repair bridge 2i1 unit
K4221-1	Glass drill machine 3,6 V rechargeable
K4208-1	Vacumm injector plastic
K4211	Razor blades x 5
K4230	Curring film square x 5
K4205	Pit filler 5 ml
4026	Carbide Probe
k4202-2	Crack resin set ( 10 x pipette/ampoule )
K4212-5	Glass drills ball ended 5 pcs
K4214-1	Mirror w/suctioncup flexible
K4206-1	Polish ( 10 ml )
4029	Cartonbox
4030	Foam 2i1 set





**K4202**  
Crack resin 5 ml



**K4202-3**  
Crack resin set 1 ( K4208-1,  
910008, K4202 )



**K4203**  
Crack resin 20 ml



**K4204**  
Crack resin 50 ml



**K4202-2**  
Resin set ( 10 x pipette )



**K4202-1**  
Resin set 1 ( K4208-1, K4202-  
2)



**K4205**  
Pit filler 5 ml



**K4202-4**  
Pit filler set 2 ( K4211, K4230,  
K4205 )



**K4206**  
Polish 20 ml



**K4206-1**  
Polish 10 ml



**K4207**  
Gel 50 ml



**K4207-1**  
Gel 10 ml



**K4208-1**  
Pressure/vacuum piston and  
syringe



**K4225**  
Gasket for K4208-1



**K4209**  
Syringe and needle x 5



**3015**  
Syringe



# AUTO GLASS REPAIR CONSUMABLES



**910008**  
Syringe and needle



**K4211**  
Razor blades x 5



**910024A**  
Razor blades x 100



**K4230**  
Curring film square x 5



**K4210**  
Curring film roll



**910009**  
Curring film x 5



**K4212-5**  
Glass drills ball ended x 5



**910010C**  
Glass drills cylindrical



**K4212**  
Glass drills ball ended



**K4223**  
Suction cup set for UV-lamp  
and crack expander x 4



**910028**  
Resin 01 3 ml



**910028A**  
Resin 01 5 ml



**910028B**  
Resin 01 10 ml



**910003**  
Resin 1 3 ml



**910003A**  
Resin 1 5 ml



**910003B**  
Resin 1 10 ml



**910002**  
Resin 1,6 3 ml



**910002A**  
Resin 1,6 5 ml



**910002B**  
Resin 1,6 10 ml



**910004**  
Resin 2 3 ml



**910004A**  
Resin 2 5 ml



**910004B**  
Resin 2 10 ml



**910022**  
Pit filler 3 ml



**910022A**  
Pit filler 5 ml



**910022B**  
Pit filler 10 ml



**910023**  
Cup lub 10 ml



**910013**  
Polish 10 ml



**K4206-1**  
Polish 10 ml



**910007**  
Gasket for injector 910018



**3018**  
Circuit board for K4213-2



**4004**  
Batteri 3,6 V for previous version of drilling machine



**4008**  
Adapter 220 V



# AUTO GLASS REPAIR CONSUMABLES



**3027**  
Charging cabel



**3010**  
Box for K4200D



**3012**  
Box for K4200C and K4200H



**4029**  
Cardboard box for K4200G



**4030**  
Foam inlay for K4200G



Demonstration videos on  
**cobraxpro.com**





**K4213-2**  
Repair bridge 3in1



**K4213-3**  
Repair bridge 2i1 unit



**K4213-1**  
Repair bridge aluminium with suction cup



**910019**  
Repair bridge aluminium with suction cup



**K4213**  
Repair bridge



**K4214**  
Mirror with suction cup



**K4214-1**  
Mirror with suction cup adjustable



**910016**  
Mityvac press/vacuum pump



**K4215A**  
UV-led lamp 30 sec. curing time



**K4221-1**  
Glass drill machine 3,6 V incl. charging cable



**K4219**  
Crack expander



**K4220**  
Slide hammer



**4026**  
Carbide Probe



**2060**  
Lighter



**k4227**  
Tip for slide hammer

## Fast autoglass removal performed by just one person

There are several autoglass removal systems on the market, but ours excels in particular in the following areas.

- Speed
- Resource consumption
- Also suitable for difficult autoglass types



Simple and effective threading

## For all wire/thread types

The system can be used with all wire types:

- Triangular wire
- Square wire
- Fiber thread (tensile strength 260 kg)

Wire attachment on both cut-out counterhold and wire handle is simple and efficient.



Thread lead in with thread starter

## Suitable for difficult autoglass types

On many car and van models, space conditions can be a challenge. In such cases, standard tools can not be used without damaging the vehicle. Our autoglass removal technology, on the other hand, is suitable for all types and in the case of:

- Limited space conditions
- The vehicle is a van



Suction cup counter - the 3rd hand

## An extra hand

Our cut-out counterhold is an extra hand. For this reason, window cutting can be done by just one person. The suction cup bracket is easily moved 3-5 times in connection with the cut-out process.



Resistance with suction cup

## Interior protection

When using our two types of protectors

- Dashboard panel with suction cup
- Dashboard panel, straight

it is easy to avoid damaging the interior during the cut-out process.



## Everyone can - after a short introduction - do the work

Our cut-out system is super easy to use and everyone can do a autoglass removal after a short introduction.



## In private label and with everything you need to get off to a good start

The product range is also offered in private label to wholesalers in the automotive aftermarket. In addition to the mandatory training and coaching of the wholesaler's staff, we also offer marketing material so that you as a wholesaler get off to a good and quick start, for example:

- Programme brochure
- Demonstration video with own employees
- Website setup with customer support function

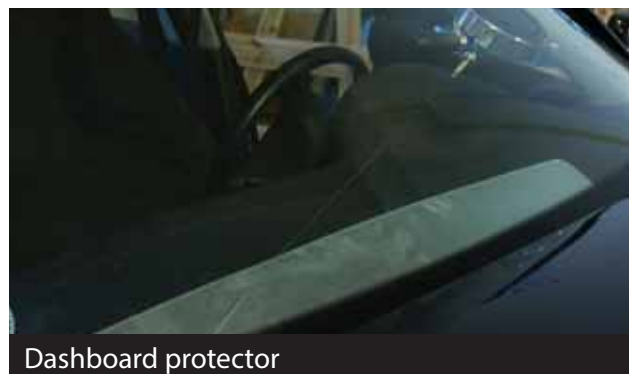



## K4500C-1

Article #	Description
K4500C-1B	Cut-out unit
3014	Suction cup for holding the wire Cut-out
K4500K	Direct wire feeder with T-handle with hole
K4500L	Dashboard protector with suction cups
R840049A	Plast protector angle
3022	Bitsholder
	Stanley knife
K45HGF-5	Fiberline tensile strength 260kg
R930020D	Triangular wire 50 m spec. for Cut-out
3011	Box for K4500C-1



## K4500

Article #	Description
K4513	Self locking wire handle with suction cup
2086-2087	Quick connection
K4500L	Dashboard protector with suction cups
R840049A	Plast protector angle
K4501	Triangular wire 25 m
2090	Box for K4500
K4514	Direct wire feeder with T-handle
2085	Cut-out spring





**K4503**  
Four edge wire 25 m



**K4503-1**  
Four edge wire 50 m



**K4501**  
Triangular wire 25 m



**K4502**  
Triangular wire 50 m



**R930020D**  
Triangular wire 50 m spec. for Cut-out



**K4550A**  
Square wire spec. 50 m



**K4504**  
Gold wire 22,5 m



**R930017B**  
Gold wire 3 m



**R840016**  
Piano wire 10 m



**K45HGF-5**  
Fiberline tensile strength 260kg



**K4500H**  
Spider fiber line tensile strength 165 kg



**K4506**  
Blade for cold knife 19 mm Ultrawiz



**K4507**  
Blade for cold knife 25 mm Ultrawiz



**K4508**  
Blade for cold knife 35 mm Ultrawiz



**K4524**  
Blade L-shape 19 mm for aircutter



**K4525**  
Blade L-shape 25 mm for aircutter



# AUTO GLASS REPLACEMENT CONSUMABLES



**R950072**  
Blade straight/curved 35 mm  
f. aircutter



**R950081**  
Blade straight 90 mm for  
aircutter



**R950097**  
Blade straight 57 mm for  
aircutter



**EES-804**  
Holder for 100 mm blade  
Equalizer



**EES-808**  
Holder for 200 mm blade  
Equalizer



**EES-812**  
Holder for 300 mm blade  
Equalizer



**ESB-1304**  
Blade 100 mm serrated  
Equalizer



**ESB-1308**  
Blade 200 mm serrated  
Equalizer



**ESB-1312**  
Blade 300 mm serrated  
Equalizer



**K4510**  
Pinchweld scraper blade 12  
mm x 10



**K4511**  
Pinchweld scraper blade 16  
mm x 10



**K4512**  
Pinchweld scraper blade 12  
mm x 10



**K4510B**  
Pinchweld scraper blade 12  
mm round corners x 10



**K4511B**  
Pinchweld scraper blade 16  
mm round corners x 10



**K4512B**  
Pinchweld scraper blade 20  
mm round corners x 10



**R930157**  
Feltapplicator 105 mm



**R930157C**  
Feltapplicator 130 mm



**K4500S**  
Sponge for removing silicone on glass 10 pcs



**K4500T**  
Sponge for removing silicone on glass 100 pcs



**K4903**  
Ceramic cleaner 500 ml spray



**11905**  
Foam Rubber 5x5 mm roll 5 m



**K4517B**  
Suction cup for worktable



**3034**  
Suction cup for K4500C-1B



**K4500C-1B**  
Cut-out unit



**3014**  
Suction cup for holding the wire Cut-out



**SHP-150-02**  
Pump for K4500C-1B



**3062**  
Shaft for K4500C-1B



**2090**  
Box for K4500



**3011**  
Box for K4500C-1



# AUTO GLASS REPLACEMENT TOOLS



**R840017**  
Wire handle wood



**R840015**  
Cut out kit ( piano wire and wood handles )



**K4500J**  
Wireholder



**K4513**  
Self locking wire handle with suction cup



**R930184**  
Self locking wire handle



**K4553**  
Counter-holder round



**R930116**  
Counter-holder round and wire handle



**K4500K**  
Direct wire feeder with T-handle with hole



**K4514**  
Direct wire feeder with T-handle



**R930129**  
Wirestarter



**K4505**  
Cold knife easy change Ultrawiz



**R840084D**  
Cold knife aluminium with Ultrawiz blade



**R950001**  
Aircutter



**R930021**  
Pinchweld scraper with 12 mm blade



**K4509B**  
Pinchweld scraper angled with blades 12, 16 and 20 mm



**K4509**  
Pinchweld scraper set



**R840048B**  
Dashboard protector metal



**K4500L**  
Dashboard protector with suction cups



**R840049**  
Plast protector straight with suction cups



**R840049A**  
Plast protector angle



**R861012A**  
Clip remover



**K4554**  
Trim strip remover / Volvo



**R910080**  
Installation stick



**K4516**  
Long knife heavy duty



**R930053**  
Glass rcraper



**R930016B**  
Wiper arm remover spec. BMW



**K4552**  
Wiper arm remover 2 arms



**R930016A**  
Wiper arm remover



**R930016E**  
Wiper arm remover with brass insert



**R930016D**  
Wiper arm remover 2 arms Heavy duty



**R840010**  
General purpose tool short



**R840010A**  
General purpose tool long



# AUTO GLASS REPLACEMENT TOOLS



## R840018

General purpose tool short angle



## R840009

Locking strip insert tool with 5 eyes spec. truck



## R840004

Locking strip insert tool 9,5 mm eye



## R840005

Locking strip insert tool 10,5 mm eye



## R840006

Locking strip insert tool 11 mm eye



## R840007

Locking strip insert tool 12 mm eye



## R840008

Locking strip insert tool 15 mm eye



## R840009A

Locking strip insert tool with 5 eyes



## R840012

Ball-pliers long



## R840011

Ball-pliers short



## R840001

Cord insert tool 5 m



## R840002

Cord insert tool 7 m



## R840003

Cord insert tool 8 m



## K4515B

Double suction cup with extra lip adjustable



## K4515A

Double suction cup



## K4515

Double suction cup with extra lip



**R840054**  
Suction cup vacuum pump Ø  
230 mm



**R840051**  
Single suction cup



**R840053**  
Large suction cup Pannkoke



**R910056**  
Mouldingpress



**3022**  
Bitsholder



**2086-2087**  
Quick connection



**WSP-003-S**  
Spider cut-out set



**K4500H**  
Spider fiber line P8



**MS-180-WSP**  
Spider cutting line install tool



**WSP-003K-2**  
Spider shaft



**WSP-003K-BIT-L**  
Spider bit short



**WSP-003K-BIT-K**  
Spider bit short



**WSP-003K-3**  
Spider bearing for shaft



# AUTO GLASS REPLACEMENT TOOL



**K45HGM**  
Milwaukee cordless caulking gun 12 V 310 ml with charger and battery



**K45HGK-01**  
Milwaukee cordless caulking gun 12 V 420 ml with charger and battery



**K45HGK**  
Milwaukee cordless caulking gun 12 V 600 ml with charger and battery



**K45HG-1**  
Milwaukee cartridge adapter black/black



**K45HG-1A**  
Milwaukee sausage adapter red/black



**K45HG-5A**  
Milwaukee barrel alu 600 ml



**K45HG-6A**  
Milwaukee barrel alu 420 ml



**K45HG-7**  
Milwaukee barrel clear 600 ml



**K45HG-8**  
Milwaukee barrel clear 420 ml



**K45HG-21**  
Milwaukee akku drill machine 12 V with charger and battery



**K45HG-4**  
Milwaukee charger 12 V



**K45HG-3**  
Milwaukee battery 12 V 2,0 AH



**K45HG-22**  
Milwaukee battery 12 V 4,0 AH



**K45HG-9**  
Milwaukee cordless multi grinder 12 V



**K45HG-10**  
Milwaukee cordless multi grinder 12 V with battery



**K45HG-11**  
Milwaukee cordless multi grinder 12 V with charger and battery





Don't work harder,  
work smarter...



Make autoglass replacement:

- A 1-person job
- Efficient
- Economic
- Ergonomic

S10198  
Windshield lift

S10200  
3m wall mounted system

S10300  
3x3m ceiling-mounted rail system

Several mounting options make installation in your system simple

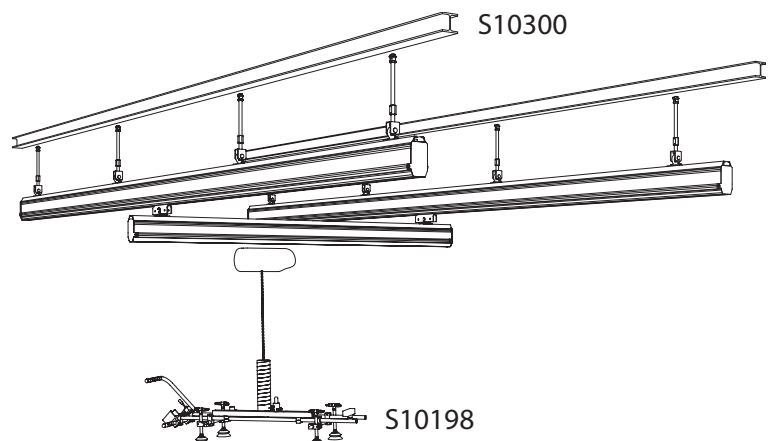
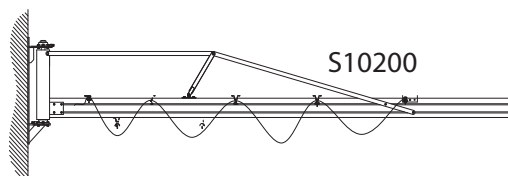



# AUTO GLASS REPLACEMENT EQUIPMENT



**K4517**  
Worktable for glass standard



**K4517A**  
Worktable for glass Luxury



**R840033**  
Worktable for glass combi  
100 cm



**R840033A**  
Worktable for glass combi  
120 cm



**R840033B**  
Worktable for glass combi  
130 cm



**K4600-2-1**  
Glasstable with tilt function  
and vacuum suction cup ( for  
trolley )



**K4600-2**  
Glasstable with tilt function  
and vacuum suction cup with  
double lip ( for trolley )



**K4600-2-2**  
Glasstable with tilt function  
and vacuum suction cup ( for  
worktable )



**K4600-2-3**  
Glasstable with tilt function  
and vacuum suction cup with  
double lip ( for worktable )



**K4603**  
1-man instalation tool



**K4650**  
Windscreen lift for car / van  
max 80 kg



**K4600**  
Windscreen lift for car / van  
max 40 kg



**K4700**  
Windscreen lift for bus / truck  
max 140 kg



**R840047**  
Workstair for tyres



**41JM30**  
Workstair 30 cm



**41JM52**  
Workstair 52 cm

# AUTO GLASS REPLACEMENT EQUIPMENT



**R870020**

Autoglass shelf single 15 rooms



**R870010**

Autoglass shelf Double 30 rooms



**R870040**

Autoglass shelf van 4 rooms



**R870030**

Autoglass shelf wall mounting 3 rooms



**R840045A**

Hoodcover ( available with your logo )



**R840046A**

Seatcover double ( available with your logo )



**R840052**

Tension strap 5 m

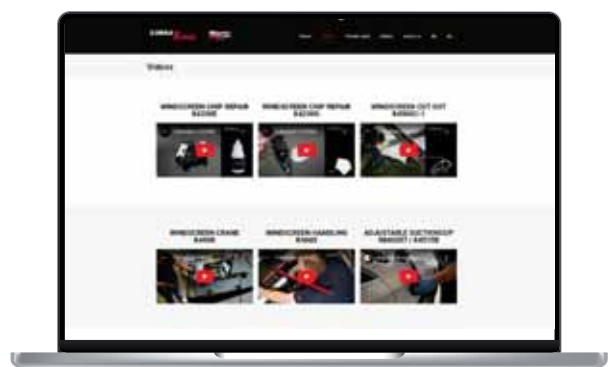

Demonstration videos on  
**cobraxpro.com**





## HEADLIGHT POLISHING/COATING SYSTEM



### K4300

Article #	Description
K4312	Polishing machine SXE400
K4315	Interface pad
K4311	Masking tape
K4302	Sanding dish K400 x 30
K4303	Sanding dish K800 x 30
K4304	Sanding dish K1500 x 30
K4305	Sanding dish K3000 x 10
K4314	Cleaner for headlight x 2
K4317	Polish 50 ml
K4318	Polishing pad orange x 2
K4324	Headlight coating 30 ml



## HEADLIGHT POLISHING/COATING TOOLS



### K470 K4312 0

Polishing machine SXE400



**K4302**  
Sanding dish K400 x 30



**K4303**  
Sanding dish K800 x 30



**K4304**  
Sanding dish K1500 x 30



**K4305**  
Sanding dish K3000 x 10



**K4314**  
Cleaner for headlight x 2



**K4324**  
Headlight coating 30 ml



**K4325**  
Headlight UV-coating spray



**K4317**  
Polish 50 ml



**K4318**  
Polishing pad orange x 2



**K4311**  
Masking tape



**K4329**  
Adapter for interface pad



**K4315**  
Interface pad

**COBRA**X**PRO**<sup>®</sup>

– auto glass repair and replacement systems

Wibotec A/S

Engmarken 11, DK-8220 Brabrand

+45 87 25 11 20

[info@wibotec.com](mailto:info@wibotec.com)

[cobraxpro.com](http://cobraxpro.com)